

H-300 Fuel Cell Stack User Manual

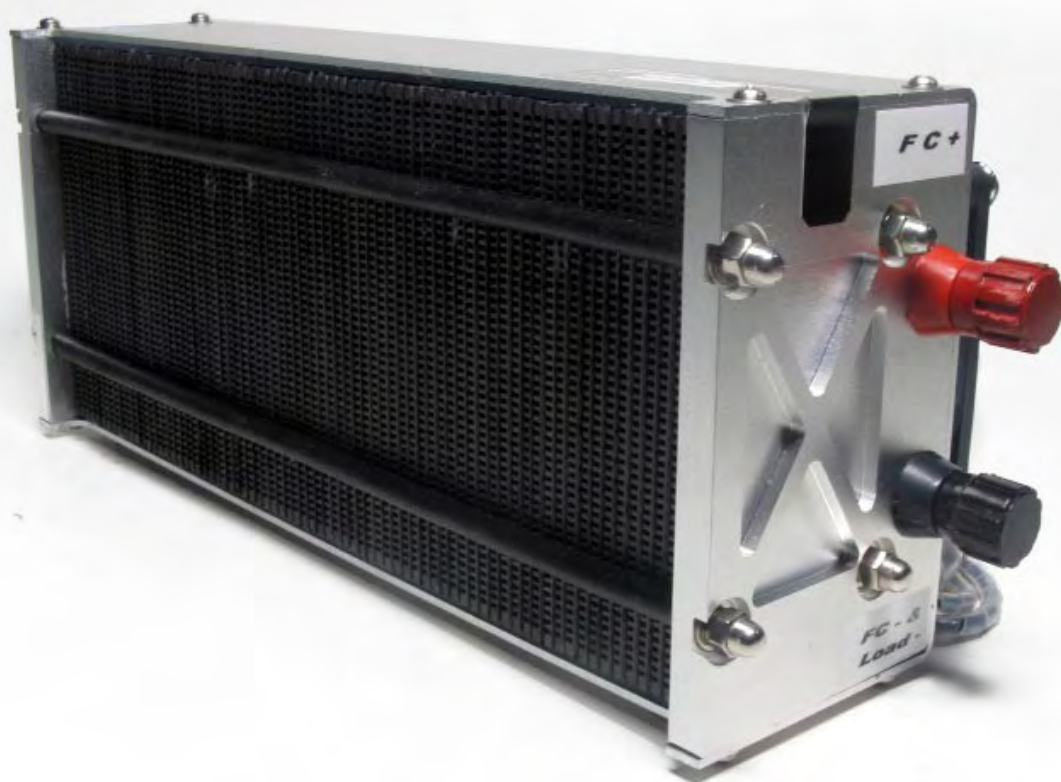

Updated 18 May 2011

Disclaimer

This manual incorporates safety guidelines and recommendations. However, it is not intended to cover all situations. It is the responsibility of the customer to meet all local safety requirements and to ensure safety during operation, maintenance and storage of the H-300 stack.

Although all efforts have been made to ensure the accuracy and completeness of the information contained in this document, Horizon reserves the right to change the information at any time and assumes no liability for its accuracy.

Actions that will void the fuel cell and controller warranty:

- Attempt, under any circumstance, to disassemble or inappropriately tamper with the fuel cell.
- Operate the fuel cell with a controller not designed and built by Horizon for the specific fuel cell.
- Operate the fuel cell with valves and blowers, that are not provided by Horizon for the specified fuel cell and controller.
- Disassemble the fuel cell.
- Disassemble the controller.
- Operating the fuel cell and controller that is not in the setup and/or specified in the user manual provide for the specific product.
- Operate the fuel cell stack without the controller produced by Horizon or with the controller not produced by Horizon.

There will be no repair, replace or refund should disassembly or tampering occur. If you have questions or need help with regards to the fuel cell and its technology please contact:

support@horizonfuelcell.com

IMPORTANT

In order for the warranty to come into effect the stack must be registered on the Horizon Warranty Page at: www.horizonfuelcell.com/warranty.htm

Table of Contents

1. Safety.....	1
2. Terminology.....	6
3. Stack and System Component Information.....	10
4. Technical Specification.....	12
5. System Set-Up.....	13
6. System Set-up Diagram.....	20
7. Notes for the set up	21
8. Operating Procedures.....	22
9. Performance Characteristics.....	25
10. Storage and Re-Use.....	26
11. Trouble Shooting&System Checks.....	27
12. Fuel Cell Drawing.....	31
13. FAQ.....	32

1. Safety

Please read all instructions carefully prior to product use and keep this manual for future reference.

The safety guidelines included here may not cover every situation. Use common sense.

1.1 General information

For this unit to generate electrical power, a supply of hydrogen fuel is necessary. It is important for any operator to be aware of, understand, and follow all local safety requirements related to the handling of hydrogen and compressed gases. Ensure that your facility conforms to all local regulatory requirements, including building codes and recommendations.

The fuel cell system has built-in safeguards and is designed to shut down automatically if any out-of-range operating condition occurs. Possible situations include low cell voltage, high current, high temperature, low fuel pressure.

- Do not operate the stack on a grade of more than 65°C.
- Do not connect or disconnect power cables when the fuel cell stack is energised.
- Do not dismantle the system. Contact Horizon if you have any concerns about operation.

1.2 Using Hydrogen

WARNING! FIRE OR EXPLOSION

Keep all sources of ignition away from hydrogen.

This unit uses hydrogen fuel. Hydrogen is a colourless, odourless and flammable substance. It is highly combustible in the presence of oxygen and burns with a colourless flame.

Leaking gas may be hot and pose a burn danger. Stop the flow of gas – if you are not in danger – and use water to cool the area. If fire occurs, do not attempt to extinguish flames, allow the fire to burn out.

Prevent overexposure to hydrogen. Hydrogen is non-toxic but can act as a simple asphyxiant by displacing the oxygen in the air. There are no warnings before unconsciousness results. When operating the stack in an enclosure:

- Ensure ventilation slots are clear and unobstructed at all times during operation.
- Operate within the temperatures limits stated in the manual.
- Never operate if an alarm condition exists.

Note: We highly recommend customer use a hydrogen sensor(not provided) to detect the hydrogen leakage.

1.3 Handling Compressed Gas Cylinders

WARNING

Do not handle compressed hydrogen gas cylinders without training or experience.

- Use a pressure regulator to control the fuel inlet pressure to the system.
- Do not alter the fitting on a regulator. Ask experienced personnel for help.
- Do not attempt to force gas cylinder threads.
- Never transport a gas cylinder with regulators attached. Ensure cylinder caps are in place. Always use a cylinder cart with a safety strap or chain.
- Secure a high-pressure cylinder to a bench, post, or fixed object to avoid accidental contact.
- Avoid unnecessary contact with On/Off valves. They can easily move to “On” by accident.

1.4 Hydrogen Leakage

Hydrogen is colourless, odourless and tasteless. Hydrogen is non-toxic but can act as a simple asphyxiant by displacing the oxygen in the air. There are no warning symptoms before unconsciousness results.

WARNING

Inhaling hydrogen can lead to unconsciousness and asphyxiation. Hydrogen molecules are smaller than any other gas, making hydrogen more difficult to contain. It can diffuse through many materials considered airtight. Fuel lines, non-welded connections, and non-metal seals such as gaskets, O-rings, pipe thread compounds and packings present potential leakage or permeation sites. Furthermore, hydrogen’s small molecule size results in high buoyancy and diffusivity, so leaked hydrogen will rise and become diluted quickly.

Constant exposure to hydrogen causes hydrogen embrittlement in many materials. The mechanisms that cause hydrogen embrittlement effects are not well defined. Factors known to influence the rate and severity of hydrogen embrittlement include hydrogen concentration, hydrogen pressure, temperature, hydrogen purity, type of impurity, stress level, stress rate, metal composition, metal tensile strength, grain size, microstructure and heat treatment history. Moisture content in the hydrogen gas may lead to metal embrittlement through the acceleration of the formation of fatigue cracks. Hydrogen embrittlement can lead to leakage or catastrophic failures in metal and non-metallic components.

As a preventative measure, the stack must be operated in a well-ventilated area in order to inhibit potential hydrogen accumulation.

WARNING!

Always operate the stack in a well-ventilated area and ensure that ventilation slots are unobstructed.

1.5 Flammability and volatility

Hydrogen is flammable over concentrations of 4 – 75% by volume in air, and is explosive over concentrations of 15 – 59%. As a result, even small leaks of hydrogen have the potential to burn or explode. Leaked hydrogen can concentrate in an enclosed environment, thereby increasing the risk of combustion and explosion.

Hydrogen flames are pale blue and are almost invisible in daylight due to the absence of soot. Due to its high buoyancy and diffusivity, burning hydrogen rises unlike gasoline, which spreads laterally.

A flammable or explosive hydrogen mixture is easily ignited by a spark or even a hot surface. The auto-ignition temperature of hydrogen is 500 °C (932 °F). The energy of a hydrogen gas explosion is 2.4 times that of gasoline or methane for an equal volume. Hydrogen gas explosions are therefore more destructive and carry further.

WARNING!

A mixture of hydrogen and air is potentially flammable and explosive and can be ignited by a spark or a hot surface.

As in the presence of any fuel, all sources of ignition, including smoking, are not permitted in the vicinity of the stack.

WARNING!

Keep all sources of ignition away. Smoking is not permitted in the vicinity of the stack.

1.6 Oxygen Depletion

Oxygen is a colourless, odourless, non-toxic and tasteless gas. Oxygen is essential for life in appropriate concentrations.

Ambient air contains up to 21% oxygen. Oxygen levels below 19.5% are biologically inactive and may act as simple asphyxiants. Effects of oxygen deficiency may include: rapid breathing, diminished mental alertness, impaired muscular coordination, faulty judgement, depression of all sensations, emotional instability, and fatigue. As asphyxiation progresses, nausea, vomiting, prostration, and loss of consciousness may result, eventually leading to convulsions, coma, and death. At concentrations below 12%, immediate unconsciousness may occur with no prior warning symptoms.

WARNING!

Lack of oxygen can lead to unconsciousness and asphyxiation.

As a preventative measure, the stack must be operated in a well-ventilated area in order to compensate for the oxygen used within the fuel cells.

WARNING!

Always operate the stack in a well-ventilated area.

1.7 Electrical Safety

WARNING!

Avoid contact with an exposed fuel cell stack. Electrical shock can cause personal injury or death.

- Do not touch fuel cell plates or any electrical components at any time. A running fuel cell stack is a potential electrical hazard that can cause burns or electrical shock.
- Do not wear metallic jewellery – rings, bracelets, watchbands, or necklaces – when you are close to an exposed fuel cell stack.
- Minimise static discharge. If possible, ground all equipment.
- Minimise conductivity. Avoid contact with surfaces that are in contact with water or gases. Do not operate or store in wet or damp conditions.
- Never use damaged extension cords.

The stack generates up to 72VDC (open circuit voltage). This voltage decreases as current is drawn from the stack. The stack produces 43.2V at maximum power. This voltage is exposed at the output power connections. These low voltages may constitute a shock hazard and can damage electronic components if shorted. Therefore, do not touch individual fuel cells, cell voltage monitoring equipment or electrical components.

WARNING!

Do not touch fuel cells, cell voltage monitoring equipment or electrical components. Electronic components can also be damaged as the result of static discharge. To minimise this, ground all equipment in contact with the stack. Never use damaged extension cords. Minimise conductivity by avoiding surfaces in contact with water; hands and clothes must be dry. Do not operate or store the stack in wet or damp conditions.

WARNING!

Minimise static discharge. Ground all equipment. Residual reactants within the stack can develop a charge in a matter of minutes when turned off. A reading of zero volts across the entire stack does not guarantee that all fuel cells are uncharged.

WARNING!

Always assume that the fuel cell stack is charged. Jewellery (such as rings, necklaces, bracelets and watches) may concentrate an electric current when it comes into contact with charged components, or when a shock passes through the human body. Accordingly, no jewellery should be worn near the stack.

WARNING!

Do not wear jewellery near the stack.

1.8 High Temperature

The fuel cell stack is designed to operate at 65°C. At this operating temperature, the air exhaust stream temperature can reach 55°C and the cooling air stream can reach 17°C above ambient conditions. These temperatures are sufficient to cause burns or severe discomfort. Accordingly, avoid contact with the fuel cell stack, or components that convey process or cooling air.

WARNING!

Avoid contact with the fuel cell stack or components that convey process or cooling air.

2. Terminology

PEM fuel cell:

a PEM (Proton Exchange Membrane) fuel cell is a device that converts hydrogen and oxygen into water and electricity.

A fuel cell stack:

it includes a plurality of plate-like fuel cells arranged along an axis generally parallel to cell thickness with electrically conductive separator plates between each pair of cells.

Reactants:

reactant is a material used to start a chemical reaction. In the fuel cell the reactants are air and hydrogen by which the electricity will be generated.

Humidification:

humidity that the fuel cells need for running.

Blower:

supply air to the fuel cells and meanwhile decrease the temperature in the stack.

Purging valve:

the controller will control the purging time for purging the water and air gas redundant in the fuel cells.

SCU:

short circuit unit – the short circuit will be controlled for good performance of the stack.

Dead ended valve:

purge valve for the controlling of the gas purging.

Mass flow per minute:

the total amount of the hydrogen flow through the fuel cell every minute, which the hydrogen supply can be calculated.

HFCT:

Horizon Fuel Cell Technologies

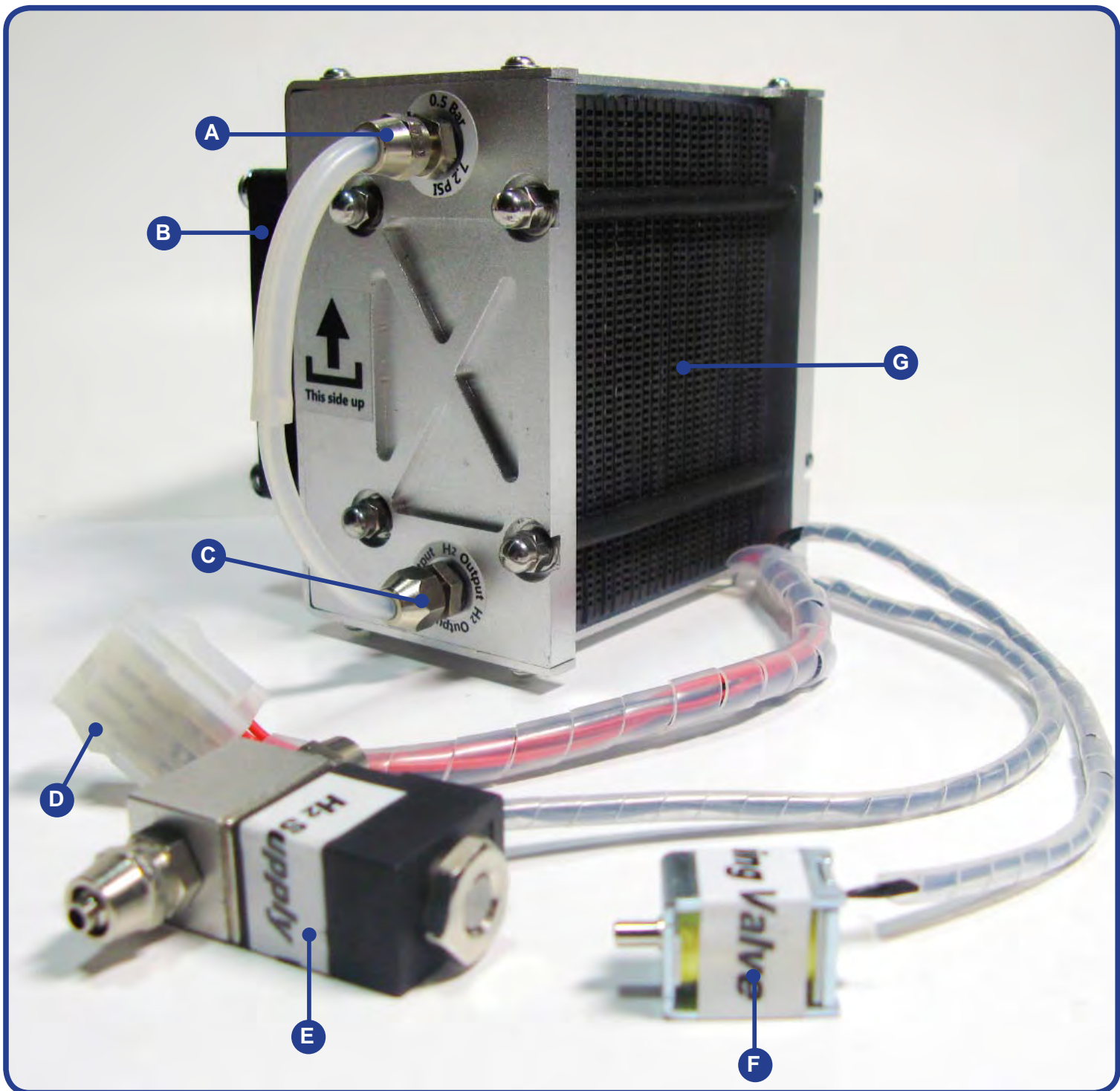

- A: H2 inlet connector
- B: Blower
- C: H2 outlet connector
- D: Controller connection with the multi-connector
- E: H2 supply valve
- F: H2 purge valve
- G: Fuel cell air inlet side

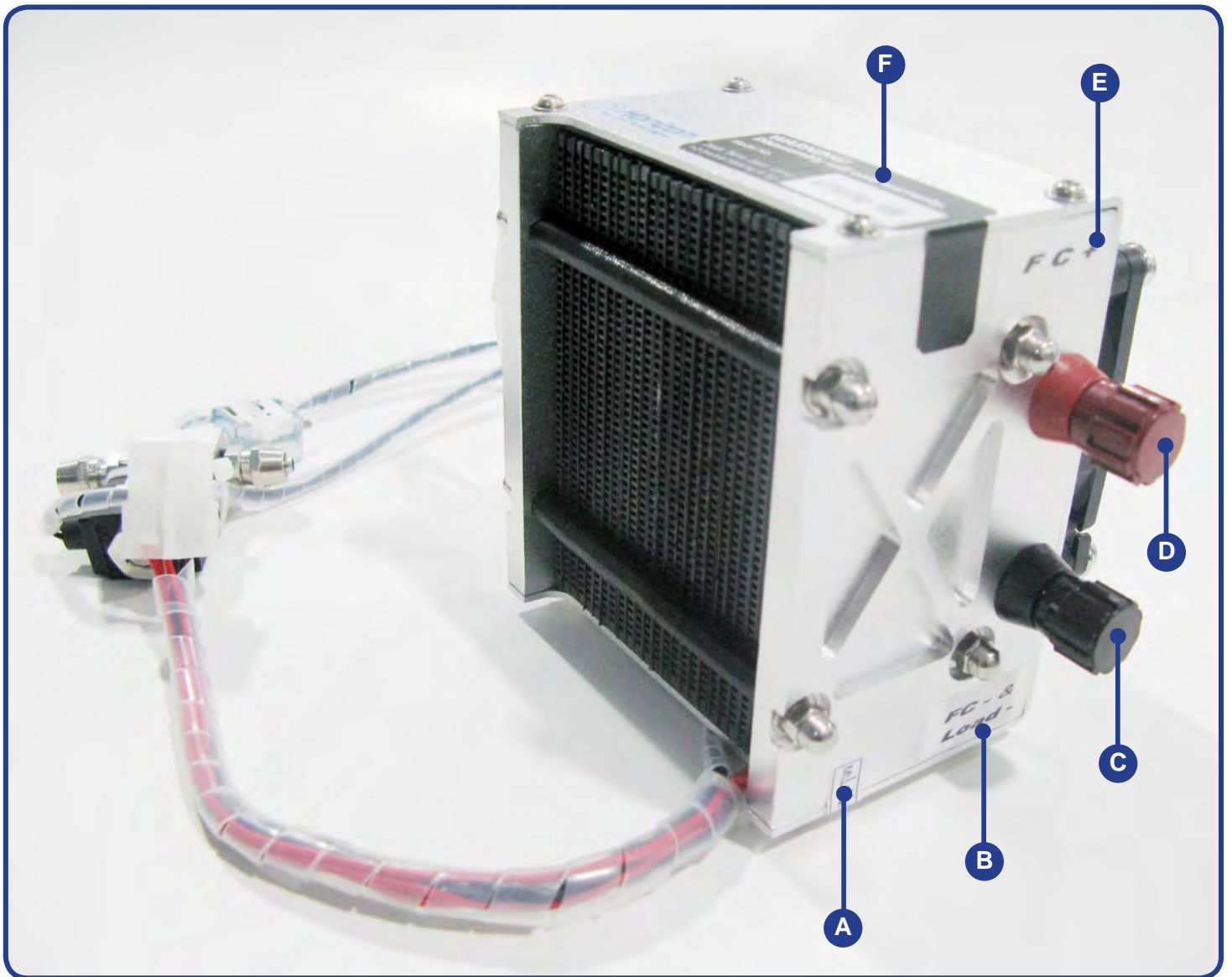

- A: Protection label
- B: FC- & load- stick
- C: FC- & load- connector
- D: FC+ connector
- E: FC+ stick
- F: Warning labels

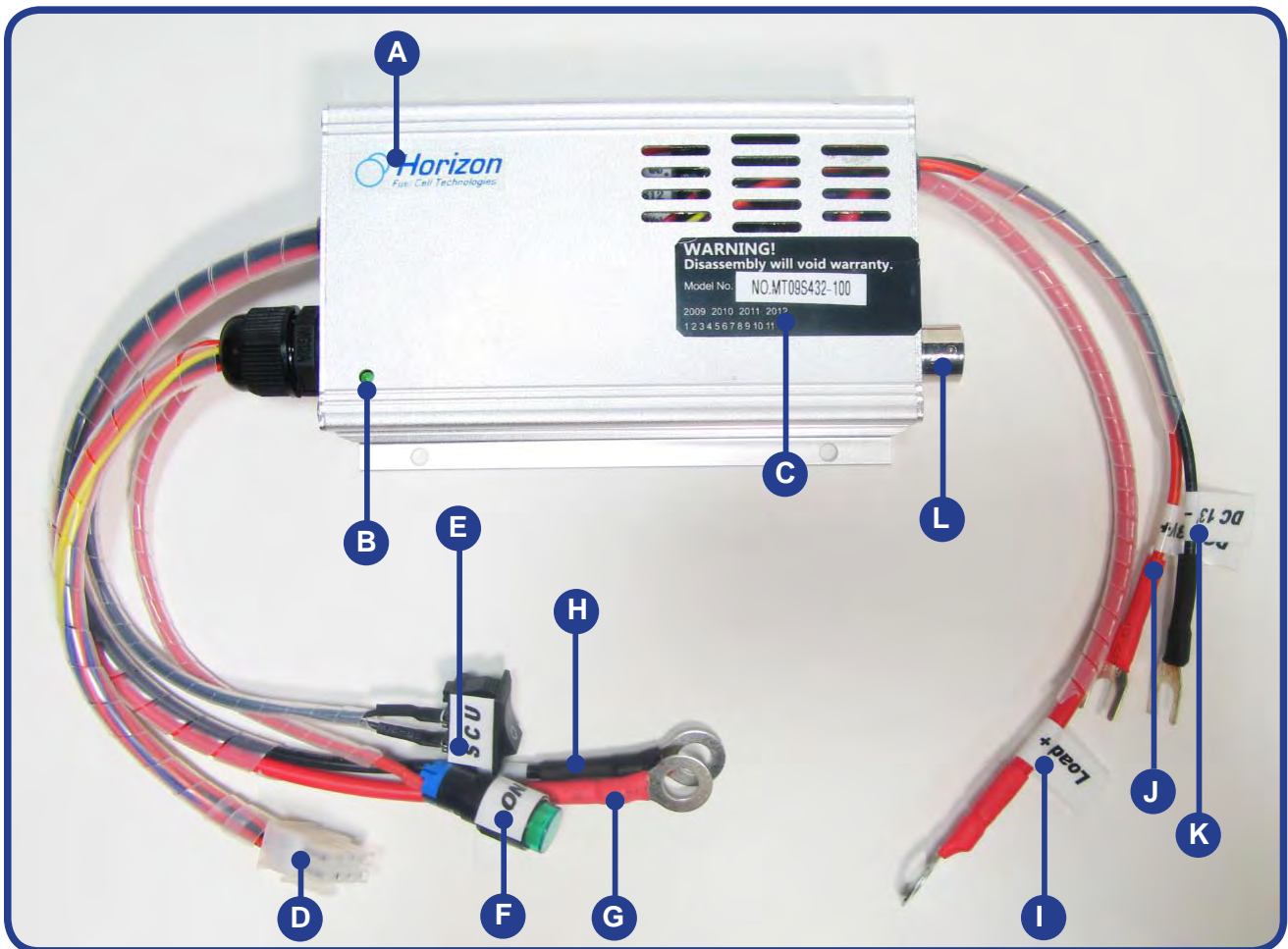

- A: Logo
- B: LED
- C: Product No.Label
- D: Connect plug
- E: SCU(short circuit units) switch
- F: ON/OFF button
- G: Connect to FC+
- H: Connect to FC-
- I: Connect to Load+
- J:Controller power supply DC 13V+
- K:Controller power supply DC 13V-
- L:LCD connector

3. Stack and System Component Information

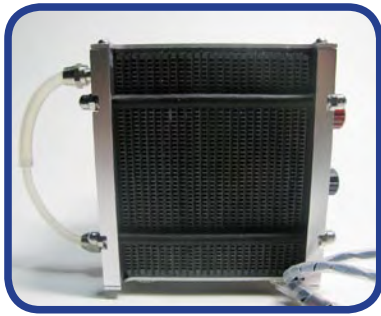

1. Stack

Is made up of plate-like cells with air channels to allow the flow of air across the membrane. The membrane facilitates the flow of Hydrogen creating the release of electrons. Electrically conductive separator plates between each pair of cells enable the flow of electrons. The stack aspect is that they are all placed on top of each other and held together by epoxy endplates.



2. H2 Supply Valve

It controls the H2 input. When the controller turns on, also the H2 supply valve does. When system turns off, it is in the off position for preventing hydrogen leakage.



3. H2 Purge Valve

It purges out the water and air gas redundant in the fuel cells.

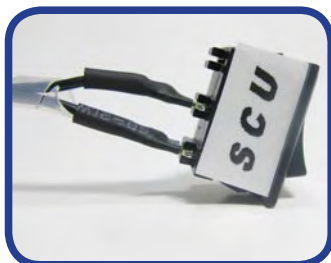

4. Short Circuit Unit

It ensures best performance of the fuel cells.



5. On/Off Switch

Hold it for 2 seconds for either on or off operation.



6. Blower

Supply air to the fuel cells and meanwhile decrease the temperature of the stack.



7. Controller Connector

Connect the stack to the T-sensor/blower/purging valve/ input valve on the controller.



8. Controller

Controls the stack temperature, blowers, hydrogen input, purging and short circuiting of the stack.



9. H2 Input/Output connectors

H2 OUT: connect the tube shown in 12 below.

H2 IN: connect the tube shown in 11 below.



10. Fuel Cell +/- Load Connectors

FC+ is connected to the fuel cell positive pole.

FC- is connected to the fuel cell negative pole.



11. Tube for H2 Input

The tube with 6mm outer diameter and 3mm inner diameter is connected to the H2 IN as in 9 above and to the input valve of the hydrogen source.



12. Tube for H2 Output

H2 output tube with 4mm outer diameter and 2mm inner diameter is connected to the purging valve on one end and the H2 OUT the other.

4. Technical Specification

Type of fuel cell	PEM
Number of cells	72
Rated Power	300W
Performance	43.2V @ 7A
H2 Supply valve voltage	12V
Purging valve voltage	12V
Blower voltage	12V
Reactants	Hydrogen and Air
External temperature	5 to 30°C
Max stack temperature	65°C
H2 Pressure	0.45-0.55bar
Hydrogen purity	≧ 99.995% dry H2
Humidification	self-humidified
Cooling	Air (integrated cooling fan)
Weight (with fan & casing)	2050 grams(±50grams)
Controller	400 grams(±30grams)
Dimension	28cm x 11.2cm x 9.5cm
Flow rate at max output*	4.2 l/min
Start up time	≦ 30S at ambient temperature
Efficiency of stack	40% @ 43.2V
Low voltage shut down	36V
Over current shut down	12A
Over temperature shut down	65°C
External power supply**	13V (±1V), <5A

* The flow rate may change with the power output.

** System electronics need external power supply.

*** The Specification is subject to change without notice.

5. System Set-Up



PLEASE READ CAREFULLY BEFORE STARTING

WARNINGS:

1. The tube between the hydrogen pressure regulator and the fuel cell gas input is required to be less than 30cm. The inner diameter of the hydrogen supply tube is required to be more than 3mm. The input pressure to the stack is required to be 0.45-0.55Bar .
2. Using the fuel cell stack with water inside can irreparably damage it!
3. Disconnect the hydrogen supply completely within 5 minutes after the fuel cell stack is shut down. Since hydrogen gas can leak into the fuel cell and destroy the stack.
4. The stack must be standing on the clear plastic feet.
5. Make sure the dry Hydrogen gas to be used must be $\geq 99.995\%$ purity.
6. Make sure you have purged the water out of the stack thoroughly if you injected water into the stack.
7. Do not vibrate the stack when it is in operation.
8. Keep the stack in ventilation when it is in operation.
9. The external battery voltage is required to be 12-14V.
10. Keep the SCU always on. Only when it causes your load operating in difficulty, turn off the SCU.
11. The tube between stack output and purging valve is required to be less than 20cm. The tube connected to the purging valve output is required to be less than 30cm. The inner diameter of the tube is required to be more than 2mm.

STEP1:

Connect the controller to the stack to get the blower, the temperature sensor, the hydrogen supply valve and the purge valve under control. The finished connection is shown in 1B.



1A

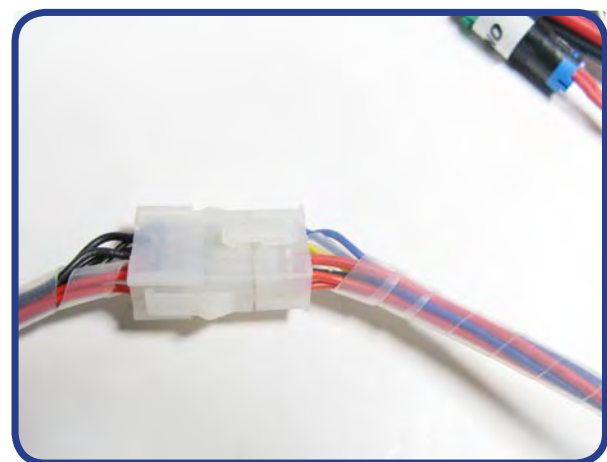

1B

Controller connector

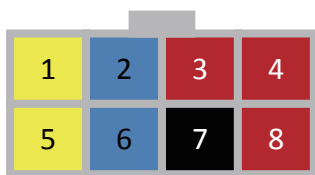

Wire colours	Connector pin #	Periferals controlled	Note
Yellow	#1 & #5	Hydrogen supply valve	Only for 100W-300W
Blue	#2 & #6	Hydrogen purge valve	
Red and Black	#3 & #7	Blowers (Red= +ve, Black= -ve)	
Red	#4 & #8	Temperature Sensor	

Blowers signal

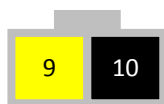

Blowers power

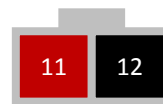

The blower is PWM control, so it needs pins #9 & #10 to give the signal to the control blowers power.

STEP2:

Connect the controller to the stack as the output power also should be under control. The finished connection is shown in 2E.

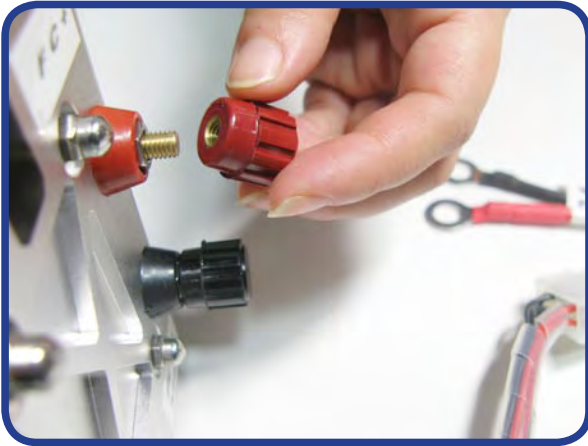

2A

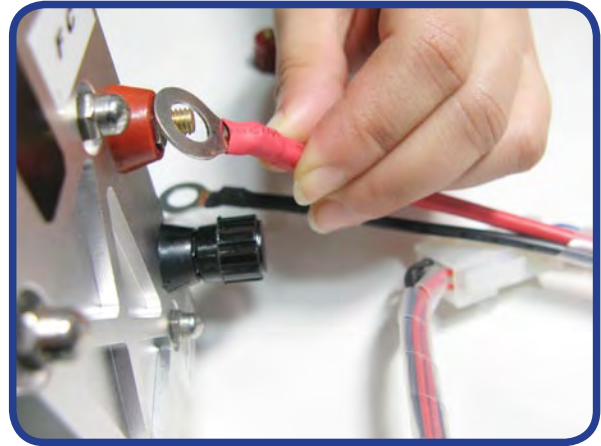

2B



2C



2D



2E

STEP3:

Keep the SCU (Short Circuit Unit) switch at “-” for usual use.

Warning: Some home appliances may not be suitable for this activation process. It may cause damaging. you can shut off the short circuit by switching it to "O", but it will cause at least 20% performance loss.



3A

STEP4:

Connect the output of the hydrogen supply valve to the stack (see the arrow on the valve). The hydrogen supply valve will prevent damage to the stack from the hydrogen while the stack is off. Pay attention to the direction of the connection of the Hydrogen supply valve. The finished connection is shown in 4H.



4A



4B



4C

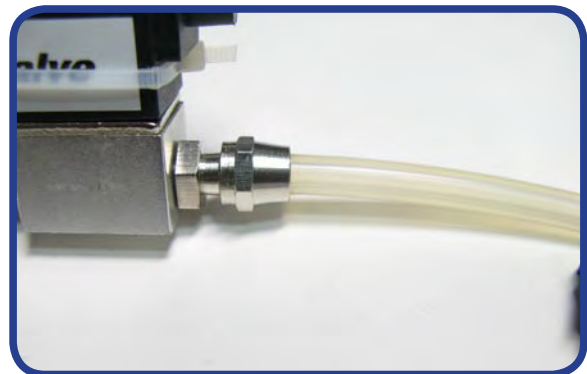

4D

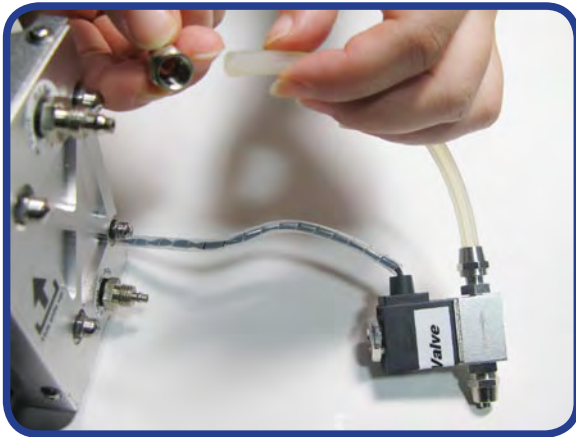

4E



4G



4F

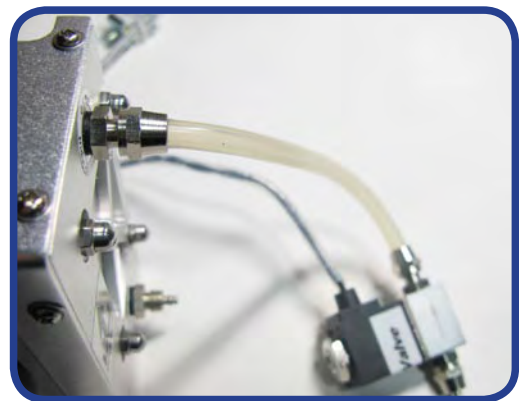

4H

STEP5:

Connect the stack to the purge valve through the filter for a longer runtime and a better performance (5A-5H). If not, the gas out of stack may have a negative effect on the purge valve after a long-time running. Connect the output of the purge valve to a place away from the stack in case of the damage caused by the Hydrogen leakage.



5A



5B



5C

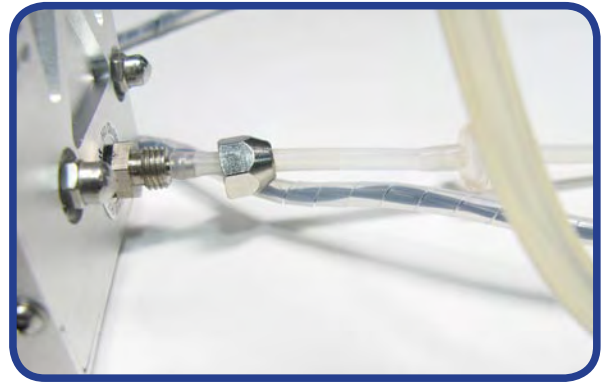

5D

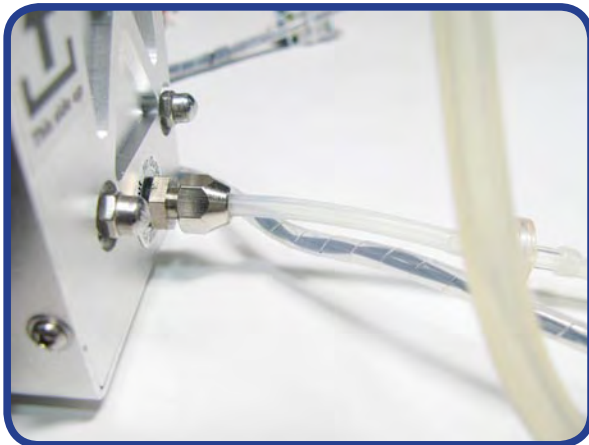

5E

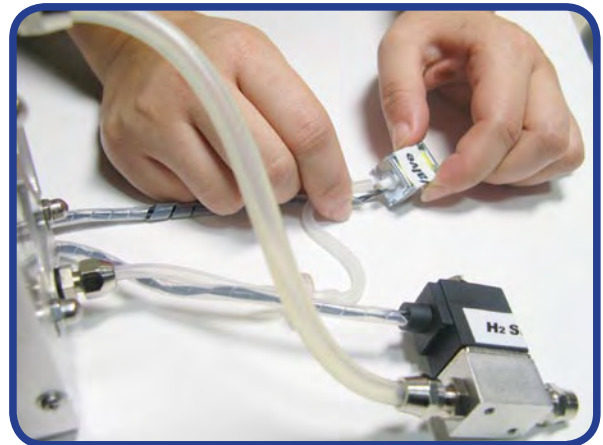

5F



5G

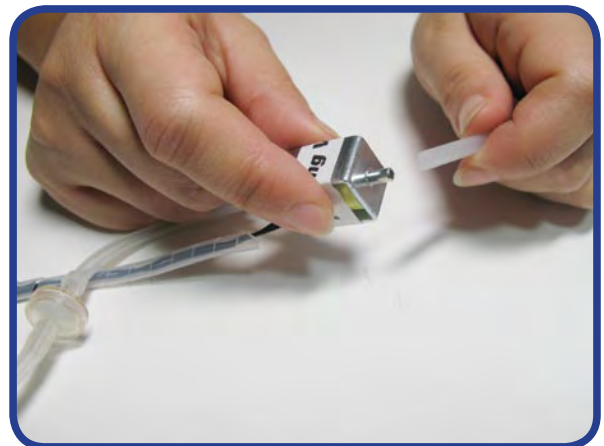

5H

Note: The tube between stack output and purging valve is required to be less than 20cm. The tube connected to the purging valve output is required to be less than 30cm. The inner diameter of the tube is required to be more than 2mm.

STEP6:

Check all the connection first and connect the load to the system, Load+ is linked to the "load+" at the controller, Load- links to the "FC- and load-" in the stack shown in 6A

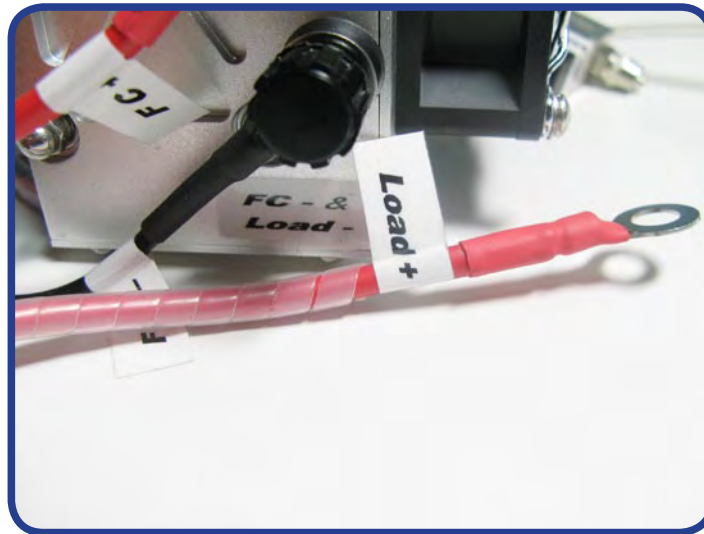

6A

STEP7:

Direct the outlet tubing of the purge valve away from the fuel cell. Do not let the purged hydrogen go back towards the fuel cell stack, this will damage the fuel cell.

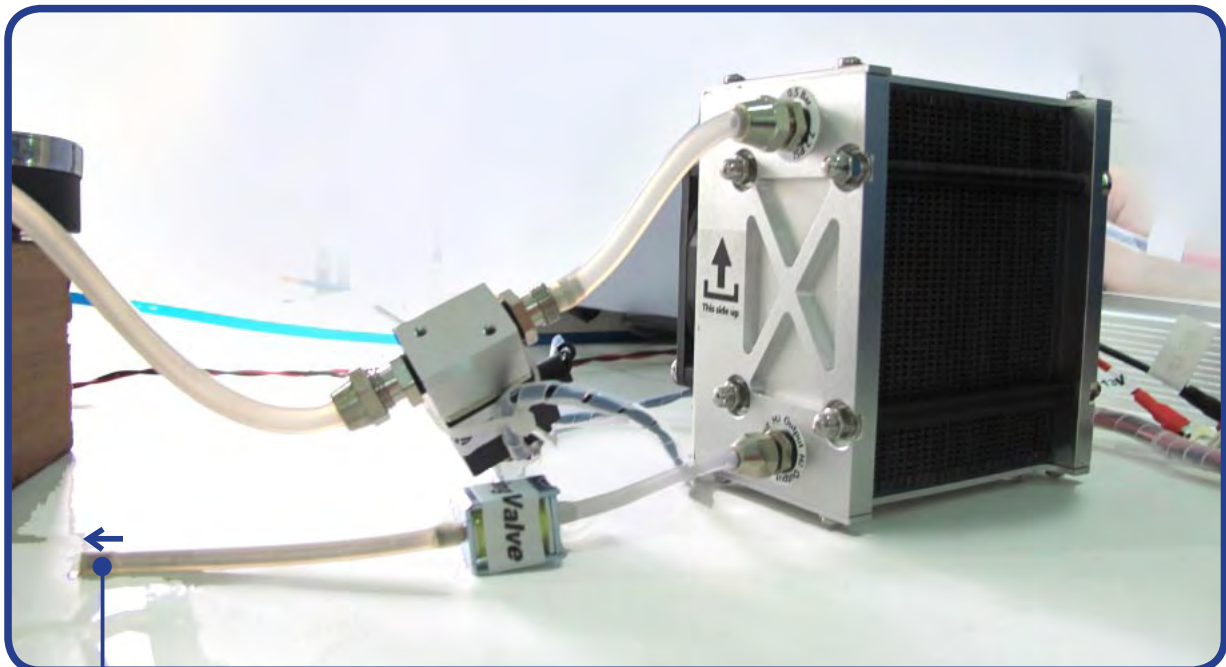

7A

Purged Hydrogen

Note: The tube is required to be less than 20cm between stack output and purging valve. The tube connected to the purging valve output is required to be less than 30cm. The inner diameter of the tube is required to be more than 2mm.

STEP8:

Connect the controller to a stabilized voltage supply through the “13V DC” connectors (8A), and the voltage of the power should be between 12V and 14V.

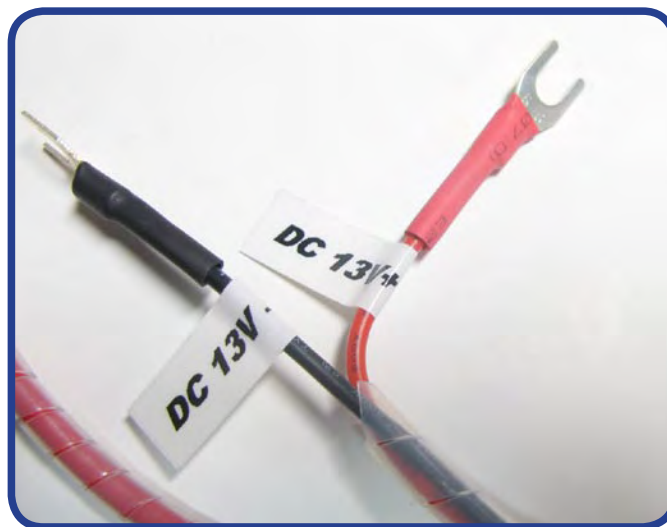

Connect the 13V external power supply to the controller,
The voltage should be between 12-14V with the current at:

- 1.5A ----- H-100
- 3A----- H-200
- 4.5A ----- H-300
- 5A ----- H-500
- 10A ----- H-1000

STEP9:

Connect the Hydrogen supply to the hydrogen supply valve, and make sure the hydrogen pressure is between 0.45-0.55Bar.

Warning: *The tube between the hydrogen pressure regulator and the fuel cell gas input is required to be less than 30cm.*

Make sure the dry Hydrogen gas to be used is ≥99.995% purity and the other gas(es) within the gas supply are not a Sulphic composition or other gases such as CO or CH4, which can all poison the fuel cell, reducing its performance dramatically.

STEP 10:

Check the following steps before starting the system:

1. The connection between the hydrogen input valve and the hydrogen source.
2. The connection between the hydrogen input valve and the stack input.
3. The connection between the stack output and the purging valve.
4. The output tube of the purging valve is kept away from stack.
5. The 8pin plug connection between the stack and the controller.
6. The "FC+/-" connection between the stack and controller.
7. The input hydrogen pressure is 0.45-0.55Bar.
8. The external battery is providing 12-14V.
9. The load is below 300W.

The System is now setup and ready to be used

6. System Setup Diagram

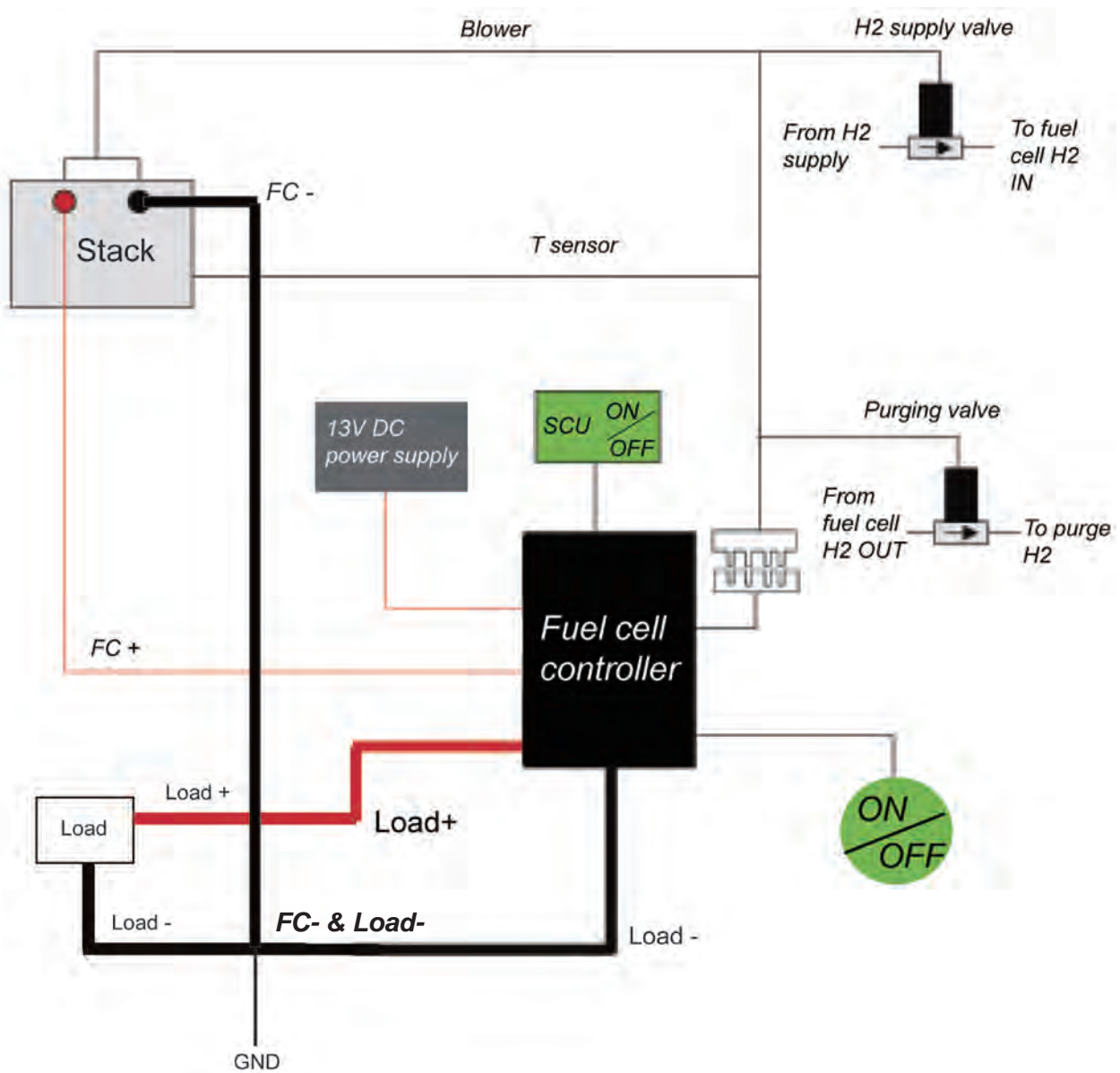

SCU: Short Circuit Unit
 GND: Grounding

7. Notes for the set-up

Note: The pictures below are only for reference.

Stack should be placed like this position. Stand on the plastic feet.

The voltage of external power supply is between 12V - 14V, the current range is different based on the different stack.

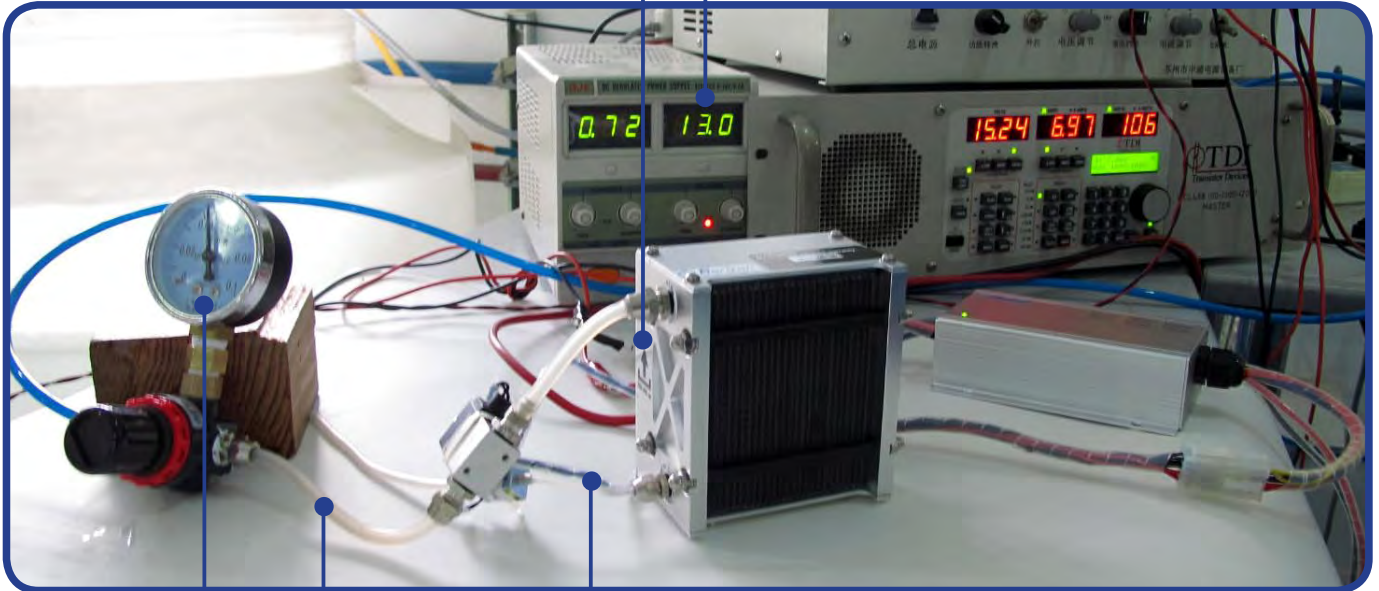

The tube is required to be less than 20cm between stack output and purging valve. The tube connected to the purging valve output is required to be less than 30cm. The inner diameter of the tube is required to be more than 2mm.

Warning: *The tube between the hydrogen pressure regulator and the fuel cell gas input is required be less than 30cm.*



The pressure of the hydrogen is between 0.45-0.55Bar.

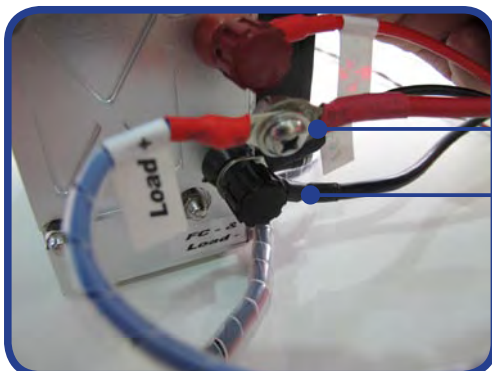

The load connector, load+, is connected to the "load +" in the controller. Connected the load- to "FC- & Load-" in the stack.

8. Operating Procedures

STARTUP PROCEDURE

Make sure both the stack and the ambient temperature are less than 45°C. Otherwise the system will not start up successfully.

Hold the ON/OFF button down for 2 seconds to start the system; you will hear one beep, which means the system has started.



If at this time the system shuts down in less than 1 second, then review the "beeping interpretation during starting procedure" on page 28.

Once the system has started, you will hear a 3 seconds long purge from the purging valve, this is the initial hydrogen going through the fuel cell to clear any non-Hydrogen gas from the system. If you do not hear the hissing from the purge valve review "Checking the Valve" in Troubleshooting.

Following the purging the fuel cell will short circuit 5 times over a 10 seconds period. If you cannot hear the 5 short circuits review "Check the SCU" in Troubleshooting.

RUNNING PROCEDURE

After system has started, depending on your setup and application you can change your load to get the power you need within the specified power range for this fuel cell.

Don't connect up a load that will demand more power than the fuel cell is rated at. This demand of power from the load can permanently damage the fuel cell.

During the operation, monitor the Hydrogen flow and pressure to consistently supply hydrogen at 0.45-0.55Bar.

Monitor the voltage of the external battery is 12-14V.

Direct the outlet tubing of the purge valve away the fuel cell. Do not let the purged hydrogen go back towards the fuel cell stack, it will damage the fuel cell (see step 7 in setup).

Pay attention to the purge, take care of the performance during the purge, If after each purge, the rise of the performance is big, it means you need to increase the pressure of hydrogen a small amount. The fuel cell is flooding and so you need to use the pressure to push the extra water out.



- Short circuit will happen every 10 seconds and last for 100ms everytime.
- If the load does not operate well with the short circuit on we recommend that you run the fuel cell for 10 minutes prior to switching the load on.
- There will be a slight decrease in the power provided to the load with the short circuit off.

Make sure the orientation of the fuel cell is kept the same during operation as shown on the fuel cell stack with the sticker "This side up".



Do not move the fuel cell around or shake vigorously during operation.

If the system shuts down during running procedure, review the Bleeping interpretation during running procedure.

SHUTDOWN PROCEDURE

To shut down the fuel cell system down, please follow these steps:

Turn off the load.

Hold the ON/OFF button down for 2 seconds to stop the system, you will hear one long beep, which means the system is shutting down.

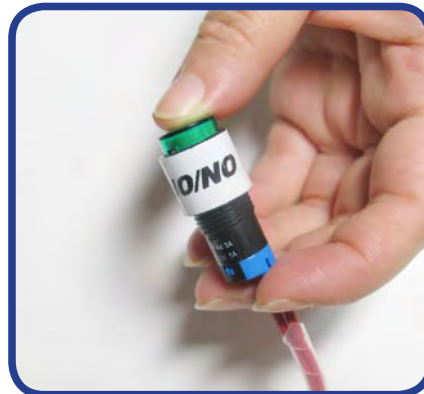

Turn the hydrogen supply off and disconnect the hydrogen supply from the supply valve.

WARNING:

Disconnect the hydrogen supply completely within 5 minutes after the fuel cell stack is finished using. Since hydrogen gas can leak into the fuel cell and destroy the stack.

If the fuel cell is not in use, please follow these final steps.

Disconnect the external power supply from the controller.

Completely disconnect the fuel cell system from the load.

Completely disconnect the fuel cell system from the controller.



Let the fuel cell cool down before placing it into an air tight container. This will help to maintain its performance particularly during long periods of storage.

9. Performance Characteristics

Performance characteristics of the stack are presented. All performance data is given for baseline operating conditions, defined at sea-level and room ambient temperature.

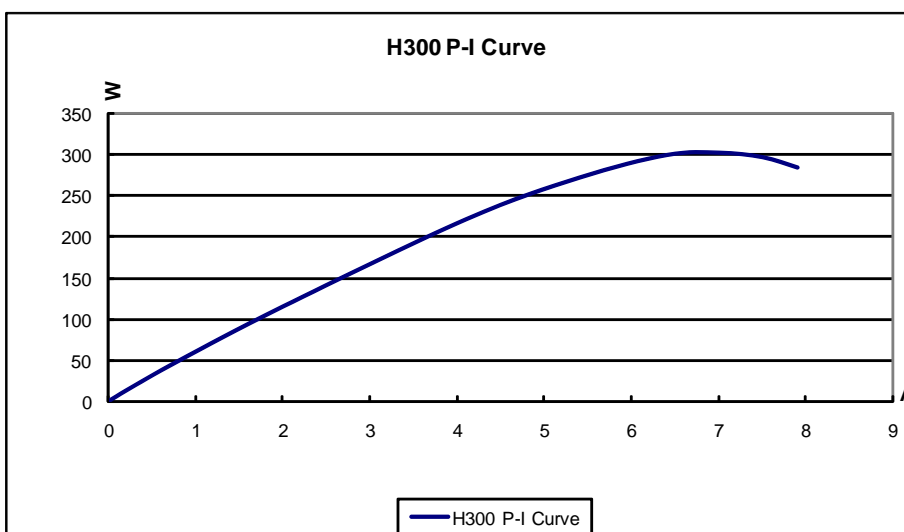
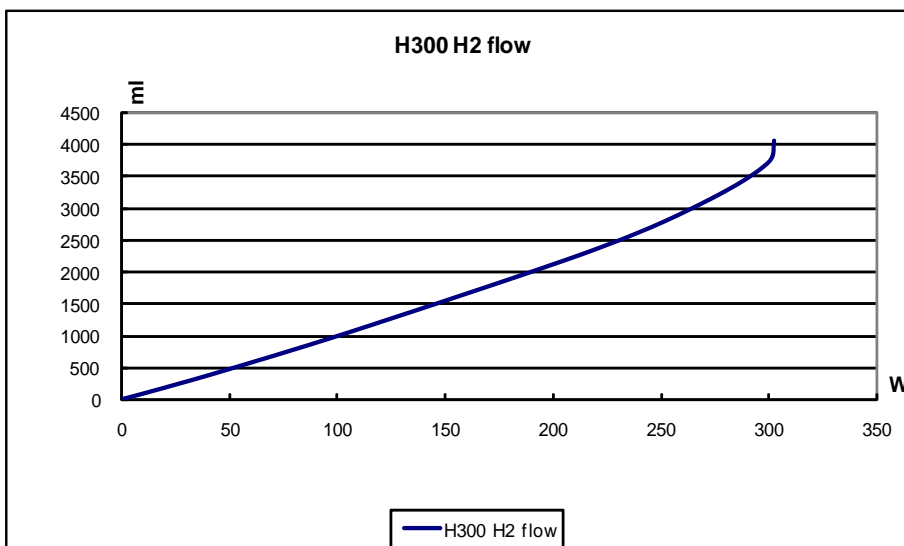
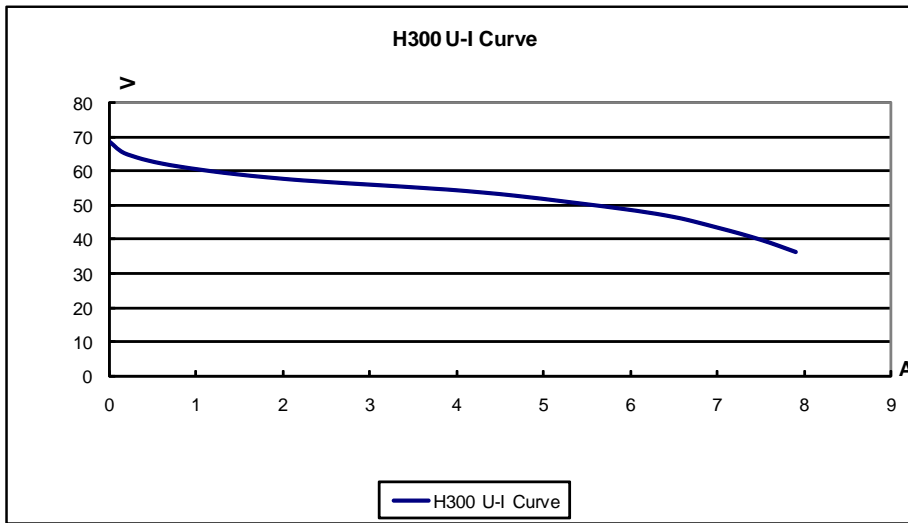

10. Storage and Re-Use

When finished operating the stack, place it in an enclosed area for storage to keep the stack from getting too dry. The stack should be stored at room temperature.

If the stack is un-used for a long period of time (more than 4 weeks) and its performance goes down 50% to the rated power at 43.2V, we recommend do the following steps.

Note: Generally, injecting water into the stack it is not recommended. Only if the performance of the stack decreases 50% is it recommended to inject water into the stack to activate the stack before operation.

Rejuvenate by injecting water into the stack:

1. Connect a short section of hosing to the gas port marked "H2 in".
2. Fill a syringe (not provided) with water (distilled or purified). Make sure there is no air in the syringe. And then connect it to the hose attached to the "H2 in" port.
3. Inject distilled or purified water into the stack until you see water coming out of the "H2 out" port (see picture A below for reference). Keep the water inside the stack for about 2 minutes. Now disconnect the syringe with the tube, and leave the water in the stack.
4. Purged the water out of the stack thoroughly before use. Connect a short tube to the "H2 out" port. And connect the H2 supply (0.45-0.55Bar) to the stack without a load attached, and **purge the stack thoroughly** (i.e. letting hydrogen flow through the stack to remove water and other contaminants). **Using the fuel cell stack with water inside can irreparably damage it!** Please see picture B below for reference.

Make sure the hydrogen supply pressure is 0.45-0.55Bar.



A

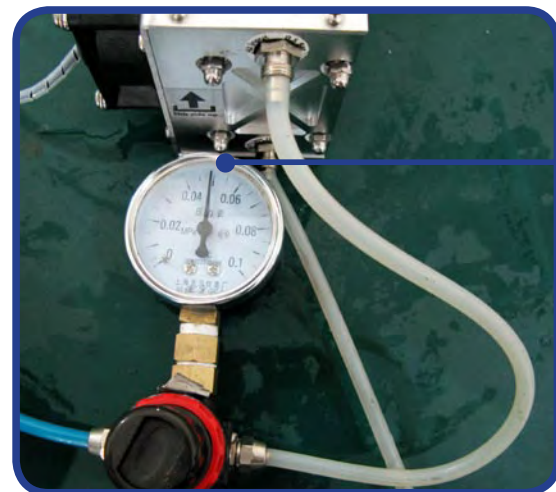

B

WARNING:

1. Please make sure you have purged the water out of the stack thoroughly before use if you injected water into the stack. Using the fuel cell stack with water inside can irreparably damage it!
2. The tube between the hydrogen pressure regulator and the fuel cell gas input is required to be less than 30cm.
3. Disconnect the hydrogen supply completely within 5 minutes after the fuel cell stack is shut down. Since hydrogen gas can leak into the fuel cell and destroy the stack.
4. When you turn off the on/off switch connected to the control box at the temperature of the fuel cell stack higher than 45°C the stack will not stop working immediately. Only when the stack temperature goes down below 45°C, the whole system will stop operation in order to protect the stack. So in order to make it work well, the fuel cell stack must be maintained lower than 45°C before operate the on/off switch.
5. The stack must be standing on the clear plastic feet.

11. Trouble Shooting & system checks

Check the external power supply

The battery might not be operating correctly or in the case of a battery may not have any charge left.

1. Disconnect the external power source.
2. Using a multimeter take a reading of the positive and negative connection points on the external power connectors to the controller.
3. If the power is <12V (<24V in H-5000) then the power is not coming through to be able to power the controller, blowers and valves.
4. Change or recharge your power supply and check the voltage that it meets the fuel cell voltage before connecting it up to the controller.

Check the SCU

1. During operation with the SCU on, the voltage of the fuel cell will drop for 100ms every 10 secs.
2. If the fuel cell voltage is not dropping then contact support@horizonfuelcell.com with the diagnostic "SCU not operational" with the controller number.

If the stack is un-used for a long period of time (more than 4 weeks and performance goes down 50% to the rated power at 43.2V):

Rejuvenate by injecting water into the stack before use:

1. Connect a short section of hosing to the gas port marked "**H2 in**".
2. Fill a syringe with water (distilled or purified). Make sure there is no air in the syringe. And then connect it to the hose attached to the "H2 in" port.
3. Inject distilled or purified water into the stack until you see water coming out of the "H2 out" port. Keep the water inside the stack for about 2 minutes. Now disconnect the syringe with the tube, and leave the water in the stack.
4. Purged the water out of the stack thoroughly before use. Connect a short tube to the "H2 out" port. And connect the H2 supply (0.45-0.55Bar) to the stack without a load attached, and **purge the stack thoroughly** (i.e. letting hydrogen flow through the stack to remove water and other contaminants). **Using the fuel cell stack with water inside can irreparably damage it!** Please see the pictures at page 26 for reference. **Make sure the hydrogen supply pressure is 0.45-0.55Bar.**

WARNING:

1. *Please make sure you have purged the water out of the stack thoroughly before use.*
2. *Using the fuel cell stack with water inside can irreparably damage it!*

Automatic Shutdown Bleeping interpretation during starting procedure

If the system shuts down before finishing the start up procedure then please refer to the following bleeping interpretation:

If the system stops during the starting:

Bleeps Interpretation Actions

1. Low fuel cell open voltage protection i.e. the average cell voltage is <0.7V.
2. High ambient temperature protection, the ambient temperature around the system is >45°C.
3. Low external power voltage protection i.e. external power is <12V.

Automatic Shutdown Bleeping interpretation during running procedure

If the system shuts down during operation within the product parameters then please refer to the following bleeping interpretation:

Bleeps Interpretation Action

1. High current protection i.e. current is too high
 - For H-100 - H-300 is > 12A set by the controller.
 - For H-500 - H-1000 is > 30A set by the controller.
2. High temperature fuel cell protection i.e. fuel cell is running >65°C.
3. Low voltage fuel cell protection i.e. the average voltage per cell is <0.5V

Note: If one of the above situations occurs, the stack will disconnect the load and make an alarm. Reduce the demand of the load on the fuel cell. The system will re-connect the load every 10 seconds. If the situation causes the initial disconnection is the same, the system will again disconnect the load.

Diagnosis	Potential for fuel cell damage?
"Fuel cell internal short circuit"	- Yes
"Controller internal short circuit"	- Yes
"Controller reading too low voltage"	- No
"Controller not operational"	- Yes
"Supply valve not opening"	- No
"Purge valve is not opening"	- Yes
"Blower(s) not operational"	- No
"LCD not operational"	- No
"High current protection"	- Yes
"High temperature fuel cell protection"	- Yes
"Low voltage fuel cell protection"	- Yes
"High ambient temperature protection"	- Yes
"Low external power voltage protection"	- No
"Temperature sensor resistance different"	- Yes

Note: If the diagnosis refers to a "Yes" from the above list, shut down the system immediately to avoid potential further damage to the fuel cell and contact support@horizonfuelcell.com.

If the system shuts down by itself check the following details

1. Make sure you have connected all wires according to the System Setup Diagram.
2. Make sure the external battery voltage is 12V -14V.
3. Make sure the input hydrogen pressure is 0.45-0.55Bar .
4. Make sure the load is below 300W. Overload can trigger the stack protection function to avoid the damage to the stack.
5. Check whether the fuel cell temperature is below 65°C, the system will shut off if it is above 65°C.

Checking the Fuel Cell System

- If the fuel cell shuts down you need to check the voltage of the fuel cell by measuring between the FC+ and FC- connectors on the fuel cell. There are 3 possible scenarios:
 - Voltage = 0
 - o Check the supply valve and purge are open.
 - If not open, see Checking Valves in trouble shooting.
 - If open, check that the wire FC+ and FC- from the fuel cell controller are connected the right way around to the fuel cell FC+ and FC- connectors, red-red and black-black.
 - If wiring wrong, change it to be correct immediately, repetitive attempts at starting the stack with this setup will permanently damage the stack.
 - If wiring correct, disconnect the FC+ and FC- from the fuel cell controller and start the fuel cell system again, it will shutdown automatically, following this measure the fuel cell voltage.
 - If voltage is still = 0, the stack has short circuited internally and needs to be changed. Contact support@horizonfuelcell.com with the diagnostic “fuel cell internal short circuit” with the fuel cell number.
 - If voltage is >0, then the controller has a problem. Contact support@horizonfuelcell.com with the diagnostic “Controller internal short circuit” with the controller number.
 - Voltage <0.6 per cell
 - o The fuel cell is dehydrated and needs re-hydrating. Follow the re-hydrating the fuel cell Conditioning the fuel cell steps.
 - Voltage >0.6 per cell
 - o The fuel cell itself is therefore fine and the fuel cell controller is reading the voltage wrong.
 - o Check the various connection points between the fuel cell stack and the controller are firmly in place.
 - o Re-start the system. If the problem continues contact support@horizonfuelcell.com with the diagnostic “controller reading too low voltage” with the controller number.

Checking Valves

1. With the system completely setup, Start the system.
2. Once the system has started, you will hear a 3 seconds long purge from the purging valve, this is the initial hydrogen going through the fuel cell to clear any non-Hydrogen gas from the system. If you do not hear the hissing from the purge valve,
 - a) Check the supply valve and purge valve are opening, this is can be done by:
 - i. Holding the valves during the starting up and feeling the clicking motion inside the valves.
 - ii. Alternatively, apply the external power directly to each valve at 12V to feel and hear the clicking of the valves opening.
 - iii. If either of the valves are not opening, then contact support@horizonfuelcell.com with the diagnostic “Supply valve is not opening” and/or “Purge valve is not opening” with the fuel cell number.
3. If the valves are opening, check before starting the system again:
 - a) The 8pins plug connector is firmly clicked together.
 - b) The hydrogen supply:
 - i. Is open.
 - ii. Input pressure is 0.45-0.55Bar.
4. If both valves open, system will follow normal start up procedures.
5. If either of the valves still don't open. Check the controller section on Valves in Trouble shooting.

Check the Blowers

1. With the system completely setup, Start the system.
2. Once the system has started, after the fuel cell system has been short circuited 5 times as part of the startup procedure the blowers will start to turn, pulling air through the fuel cell.
 - a) If all the blower(s) are creating non-standard noise, turning slowly, or not turning at all.
 - i. Check carefully that there are no obstructions in the blower(s).
 - ii. Carefully spin the blowers using your finger make sure there is rotation movement, without obstructions.
 - iii. The electrical supply from the controller needs to be checked, by applying the 12V/24V external power supply directly to the 8pin plug connector points for the fans and monitoring the performance of the blowers.
 - iv. If the blowers are not running or running slowly and the current is very high, then contact support@horizonfuelcell.com with the diagnostic “Blower(s) not operational” with the fuel cell number.
 - v. If the blower(s) are running fine. Check the controller section on Blowers in Trouble Shooting.

Check the controller

1. Make sure the system is shut down and the hydrogen supply is off.
 - a) Disconnect the Fuel cell stack from the controller.
 - b) To check that the controller is operating correctly, review the pin connector drawing against the pin connector.
 - c) Using a multimeter you can check the power being supplied to each of the peripherals (solenoid valve, purging valve, blowers) of the fuel cell.
 - i. With the external power supply connected to the controller and the fuel cell not connected to the controller, start the system up.
 - ii. The controller will run through the start-up procedure supplying power to the peripherals.
 - iii. By checking each pair of pins you will get the following power readings:

Wire colours	Connector pin #	Connected Peripherals	Voltage supplied
Blue	#1 & #5	Hydrogen purge valve	12V for 3 seconds
Yellow	#2 & #6	Hydrogen supply valve	12V constant
Red	#4 & #8	Temperature Sensor	0V
Red and Black	#3 & #7	Blowers (Red= +ve, Black= -ve)	after 3 seconds 3V constant

- iv. If any of the pins are not supply the voltage then contact support@horizonfuelcell.com with the diagnostic “Controller not operational” with the controller number and the voltage readings you are getting from the connector point.
 - d) To check the Control chip
 - i. The system does not need to be started for this.
 - ii. Connect the multimeter to the fuel cell stack 8 pin connector, pins #4 & #8.
 - iii. The resistance should be 1076ohms at 20°C ($\pm 3.8\text{ohms}$ for every $\pm 1^\circ\text{C}$) of the fuel cell temperature.
 - iv. If resistance reading is different then contact support@horizonfuelcell.com with the diagnostic “Temperature Sensor resistance different” with the fuel cell number and the resistance readings you are getting from the connector point.
 - e) Check your external power supply, to see how much current is being drawn during the starting time, it should be more than 0.6A for 3 seconds.

12. FUEL CELL DRAWING

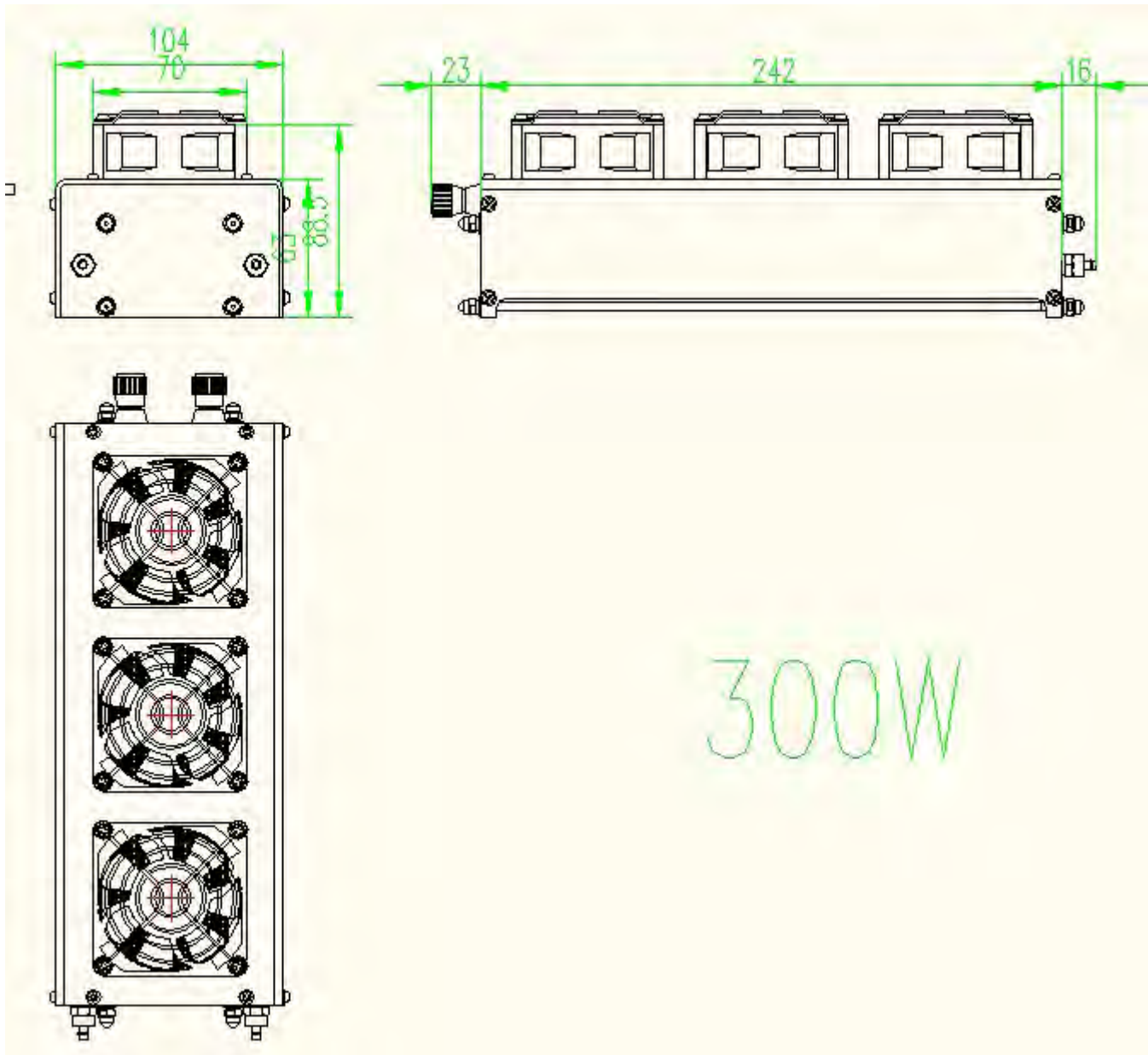

13. FAQ

What is the SCU?

This is the Short Circuit Unit, it helps to condition the fuel cell for long term good performance.

What is the Hydrogen pressure supplied to the fuel cell stack?

The pressure is required to be 0.45-0.55Bar.